

- The number shown in each  is the page number where the part's function and/or use are explained in Japanese.

Front view

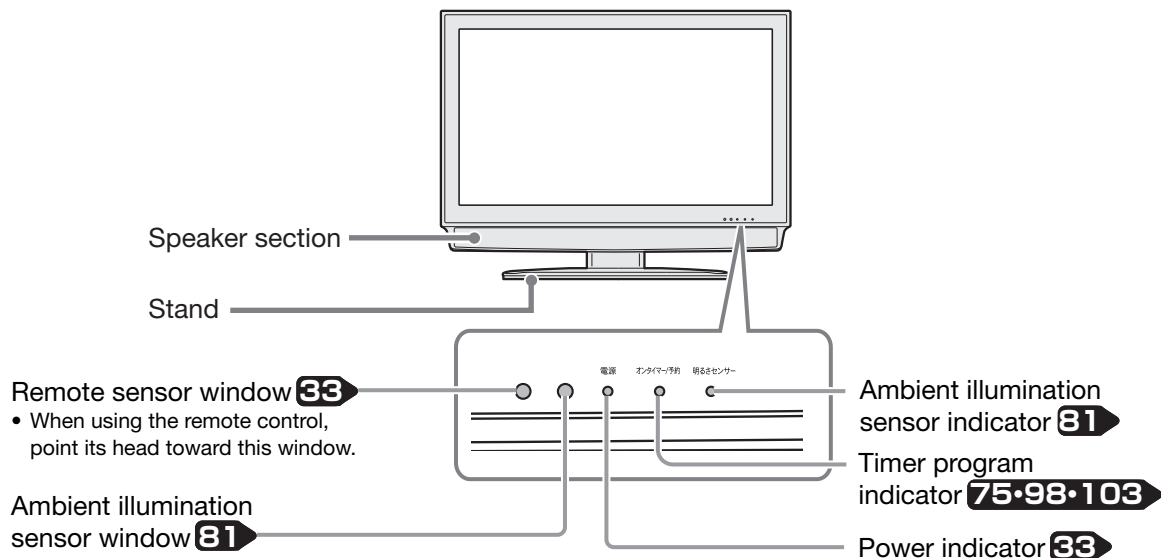

Adjusting the LCD panel angle

- The LCD panel can be tilted up to 2° forward, up to 6° backward and rotated horizontally up to 10° clockwise and counter-clockwise.
- Hold the stand firmly when you adjust the monitor's angle.

Top view

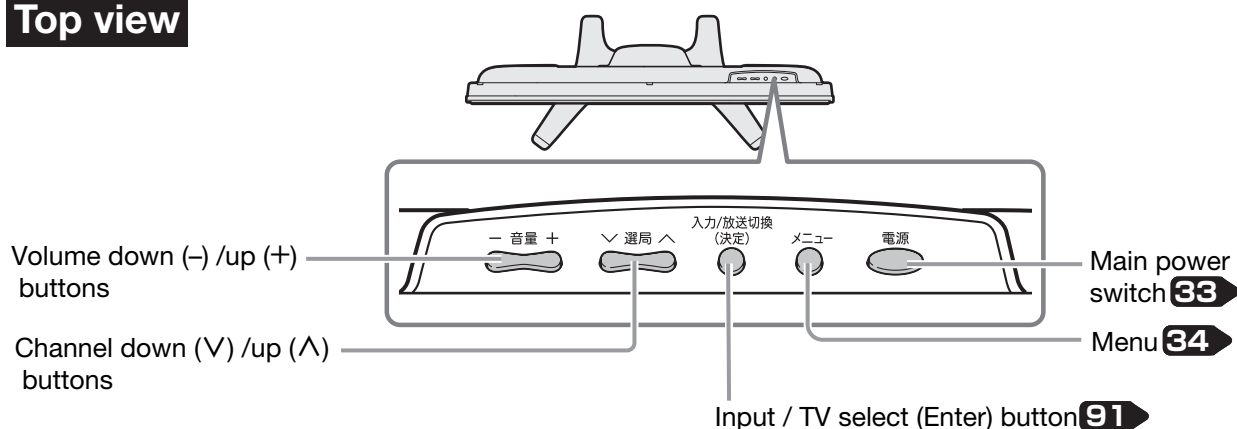

Side view

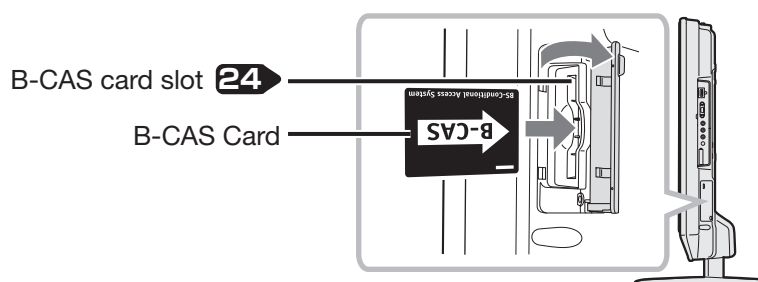

Back view The illustrations below are those of LC-32GH5.
LC-26GH5 has the same layout of jacks and terminals as.

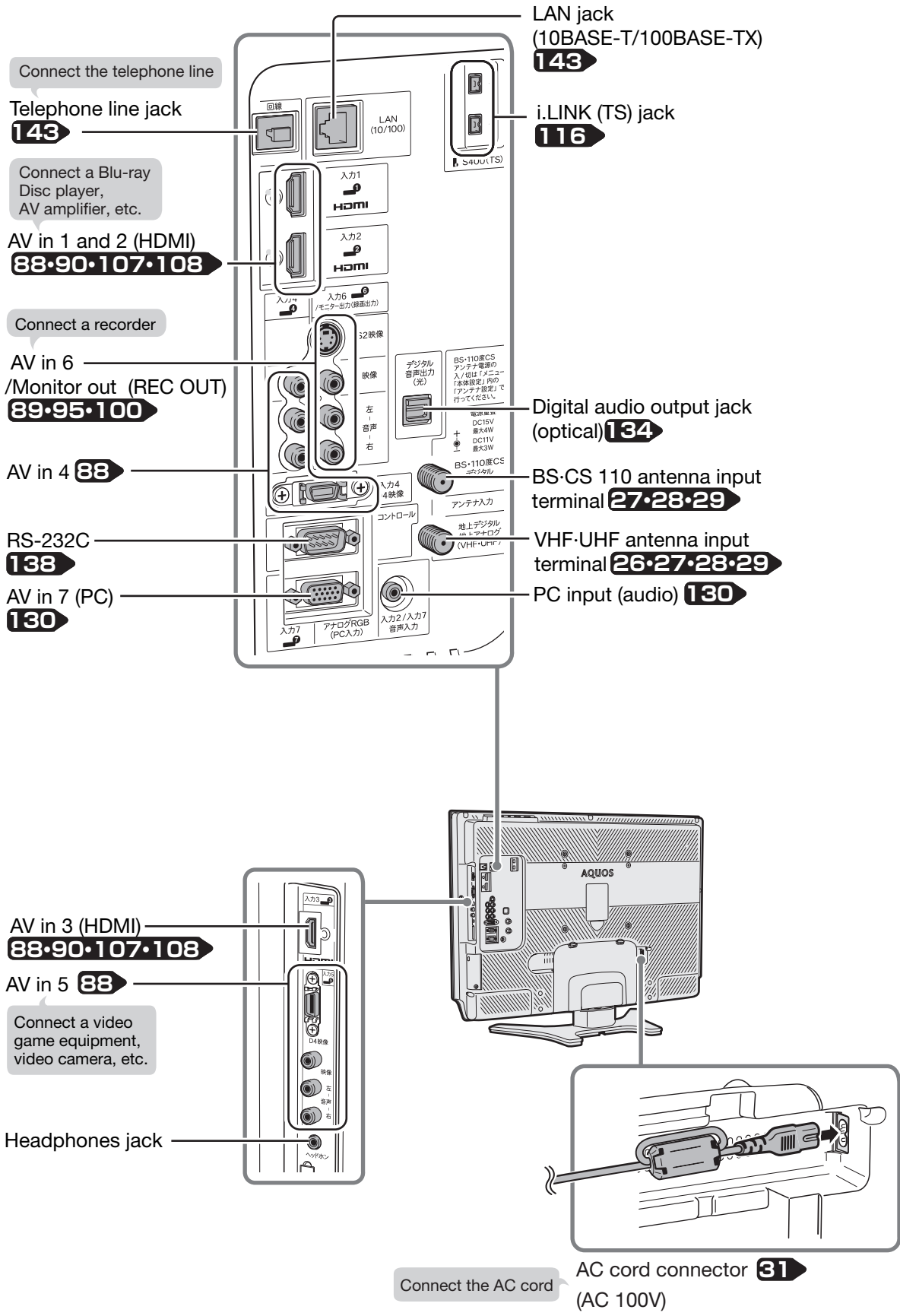

Part Names – Remote Control Unit

Active/Standby **33**

Press to engage the TV set in the active or standby mode.

CATV

CATV **63**

When selecting a CATV channel by entering the channel number, press this button first, then enter the 2-digit number with the TV channel select buttons (1-10/0).

3桁入力 Digital channel number input **63**

Use to select a digital channel by entering the 3-digit channel number.

地上A Terrestrial analog select **60**

地上D Terrestrial digital select **60**

BS BS select **60**

CS CS select **60**

Select the CS digital channel for the first time. **39**

消音 Mute

Press to temporarily turn off the sound. Press again to return the sound volume to the previous level.

+音量 Volume up (+)/down (-)

Press to adjust the volume.

Linked data broadcast **65・74**

Press to call the data broadcast linked with the current digital TV program.

AV mode select **79**

Press to select the picture/sound setting that best matches the current program.

番組表 EPG **66・68**

Press to display or turn off the Electronic Program Guide (EPG: 番組表) when receiving a digital broadcast.

裏番組 Other on-air programs **67**

Press to display the EPG for currently on-air programs only (裏番組).

番組情報 Program info **74**

Press to display detailed information on the current digital program.

Finish **34**

Press to finish menu operation, etc.

* This button can be conveniently used when you are at a loss during menu or EPG operation, etc.

お好み選局登録

Favorite channel select/register **63**

Press to select a user-registered channel and to turn on/off the favorite channel register/registered channel table screen.

映像切換 Picture select **73**

Press to select the desired picture when watching a digital multi-picture program.

字幕 Caption **73**

Press to display, select, or turn off captions when watching a digital program with captions.

音声切換 Audio select **72・73**

Press to select the desired audio.

画面表示

Display **62**

Press to display or turn off the channel call, etc.

画面サイズ

Screen mode **77・131**

Press to select the desired screen mode.

静止

Freeze **86**

Press to freeze the picture.

i.LINK

i.LINK **118**

Press to display the i.LINK control panel.

Channel select **61**

- Press to select a channel.
- Use to input a number for various settings.

↑

Channel up (^)/down (v) **61**

Press to select channels in the current network, media and CATV channels in the ascending or descending order.

* CATV channels are factory set to be skipped.

入力切換

Input select **91**

Press to select the desired input.

Media select **60**

Press to select the desired media (TV or data).

Sleep timer **150**

Press to select the desired remaining time period after which the TV set is automatically turned off and enters the standby mode.

Menu **34**

Press to display or turn off the menu screen.

*The menus can be displayed in English. See **179** for instructions on how to switch the display language.*

Cursor (up, down, left, right) **34**

Use to select a menu item, column, etc.

決定 Enter/Confirm **34**

Press to confirm a selected setting or menu item.

Return **34**

Press to go back to the previous screen. Press this button instead of the Enter/Confirm (決定) button when you have selected the wrong item or input the wrong number, etc.

青 赤 緑 黄

Color **68・69**

Use to operate EPGs and data program screens.

Familink **110・112~115**

Press to operate "Familink" Recorders and AQUOS Surround connected via HDMI cables.

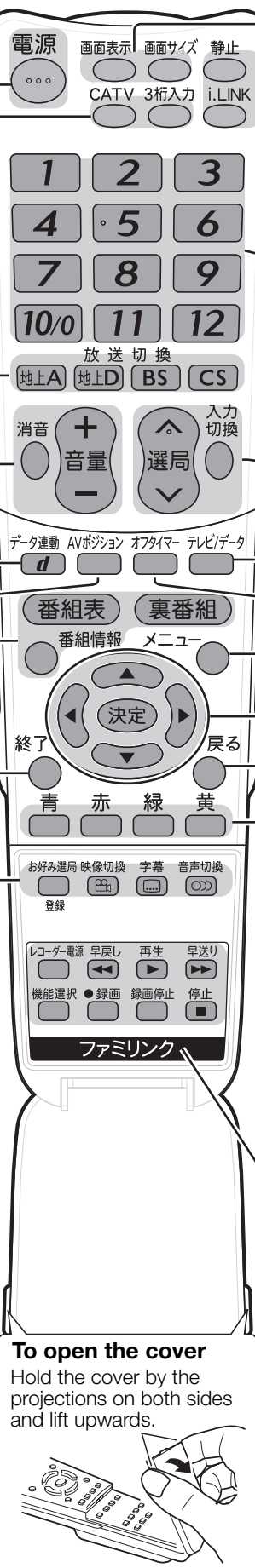

To open the cover

Hold the cover by the projections on both sides and lift upwards.

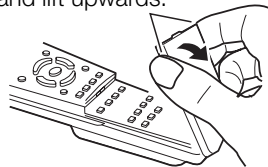

Switching the Display Language to English メニューなどの言語を英語にする

- Using the menu screen, you can switch the on-screen display language to English.

メニューなどの画面表示を英語にすることができます。



おしらせ

誤ってメニューを英語にしてしまったときは

- ・メニューから「Setup」－「言語設定 (Language)」を選んで決定し、「日本語」を選んで決定すると日本語になります。

- Press

メニュー

1 Display the menu screen.
メニューを表示する
- 決定

2 Select “ 本体設定 ”(Setup) — “Language (言語設定)”.
「本体設定」－「Language (言語設定)」を選ぶ

決定 Enter.
決定する

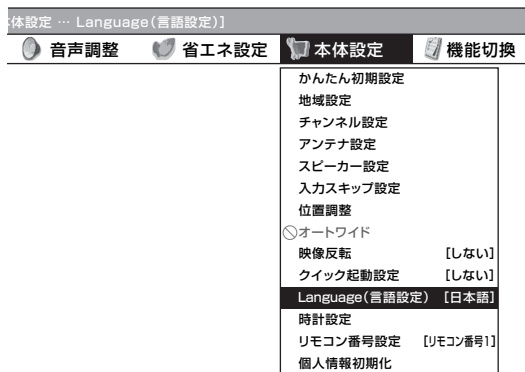

- 決定

3 Select “English”.
「English」を選ぶ

決定 Enter.
決定する

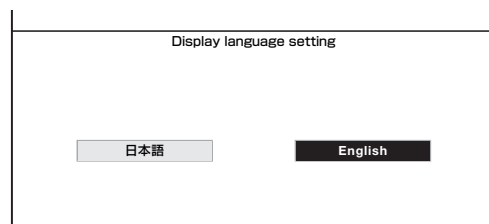

- The menu screen is now displayed in English.
- 画面表示が英語になります。

- 終了

4 Finish this operation.
終了する

はじめに

準備

番組を見る

他の機器で
録画・再生

ファミリンク
で録画・再生

本機の機能の
活用

故障かな・仕様・
寸法図など

English
Guide